

Lycos[®]
BATHWARE ● ● ●



EXCLUSIVE
SANITARYWARE COLLECTION

Collection 2022-23

brand story

THE PIECES OF ART

We are one of the well-known companies in the sector for providing Sanitaryware of an outstanding quality, using the latest technologies and innovative aesthetics. We stand for the highest reliability and values as a leading producers in the premium market. The Lycos brand of world-class products is demonstrated by the Lycos Sanitaryware, which is not just a symbol of knowledge but also of cultural inspiration.

Our products include beautiful designs, simple operation, and the highest quality. They are a wonderful fusion of form and arrangement. We always ensure that our products meet the highest qualitative needs of the customers.

C O N T E N T T A B L E

ONE PIECE
COLLECTION

→ Pag.
01

WALL HUNG
COLLECTION

→ Pag.
07

TABLE TOP
COLLECTION

→ Pag.
13

WALL MOUNTED BASIN
COLLECTION

→ Pag.
19

PEDESTAL WASH BASIN
COLLECTION

→ Pag.
21

ONE PIECE BASIN
COLLECTION

→ Pag.
25

EWC
COLLECTION

→ Pag.
27

URINAL
COLLECTION

→ Pag.
29

PAN
COLLECTION

→ Pag.
31

SEAT COVER

→ Pag.
32

ACCESSORIES

→ Pag.
33

installation
Instructions

→ Pag.
32

S A N I T A R Y W A R E



RICH SHADES FOR YOUR BATHROOM



every bath space in your home should reflect your style and taste. With the enormous choices of designer sanitary ware with us

SIPHONIC TOILET

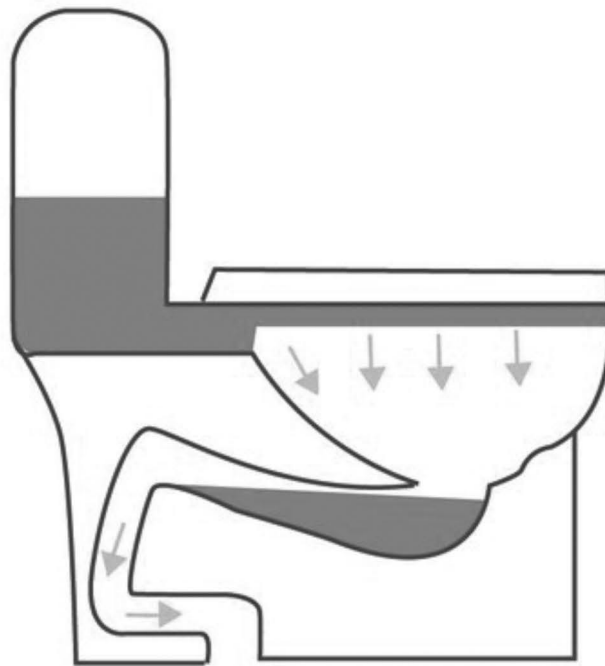

Discharge Pipe Of Siphonic Toilet is narrow & Radian is Large.



Silent



Hygienic



Easy Cleaning



Water Saving

ONE PIECE

Closet

TORNADO (1001) Siphonic

S-Trap 225mm / 300mm

L-660, W-360, H-750mm

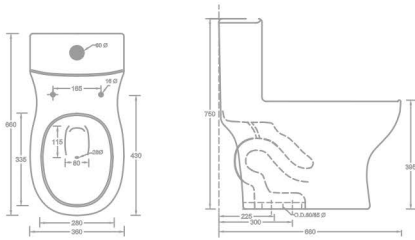

AVIATOR (1002) Siphonic

S-Trap 300mm

L-675, W-370, H-780mm

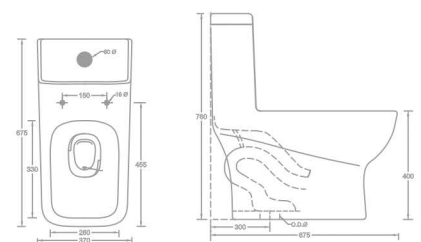



VOLVO (1003) WashDown

S-Trap 220mm
L-670, W-350, H-740mm

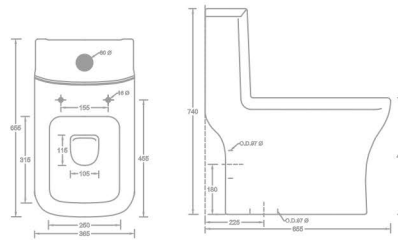

ROMANO (1004) WashDown

S-Trap 100mm, P-Trap 225mm
L-715, W-395, H-695mm

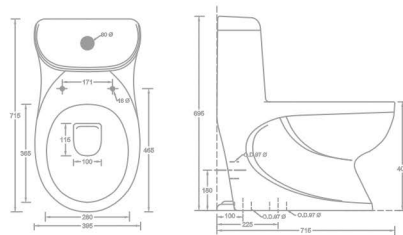

SPANIA (1005) WashDown

S-Trap 300mm
L-670, W-355, H-705mm

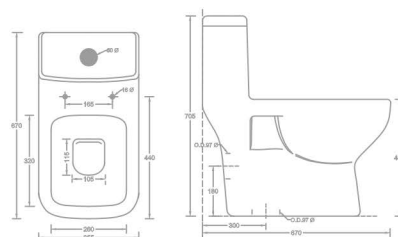

ONE PIECE

Closet

KONA (1006) WashDown

S-Trap 220mm

L-675, W-355, H-750mm

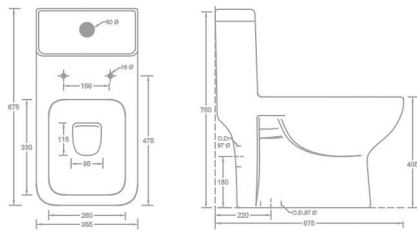

RAPID (1007) WashDown

S-Trap 225mm

L-715, W-370, H-790mm

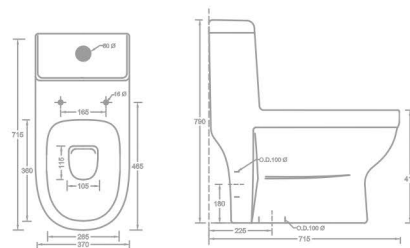

CASINO (1008) WashDown

S-Trap 225mm

L-670, W-365, H-735mm

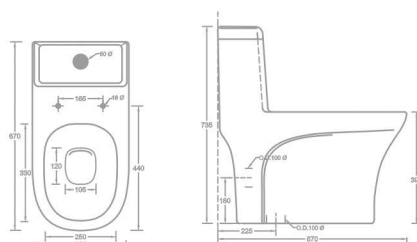



ONE PIECE

Closet

MILANO (1009) Siphonic

S-Trap 290mm, P-Trap 220mm

L-680, W-365, H-750mm

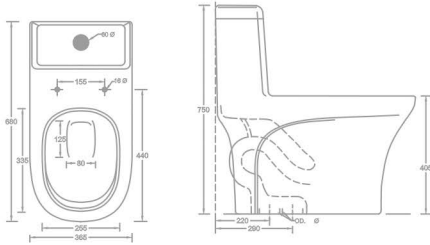

ZORO (1010) WashDown

S-Trap 220mm

L-670, W-350, H-740mm

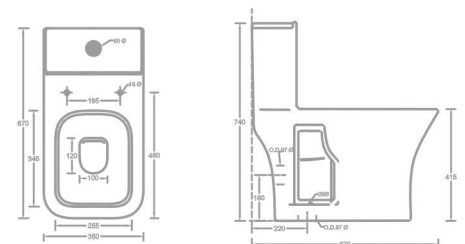



REVO (1011) Siphonic

S-Trap 225mm

L-675, W-390, H-720mm

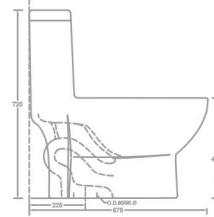
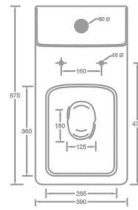

WALL HUNG

Closet

TOYO (2001)

L-510, W-350, H-360mm

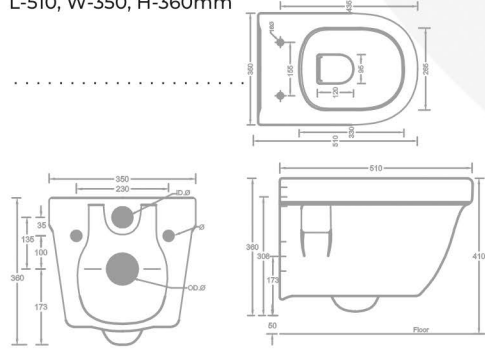

SPIDER (2002)

L-525, W-380, H-370mm

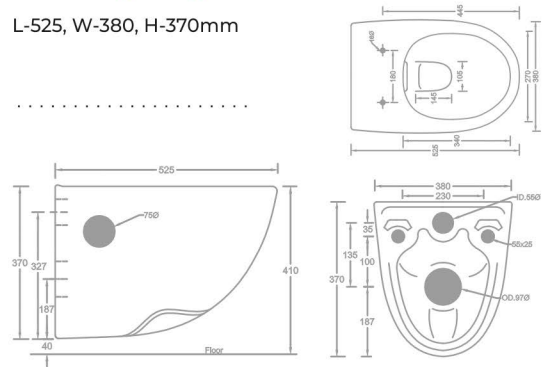

CRYSTAL (2003)

L-500, W-360, H-735mm

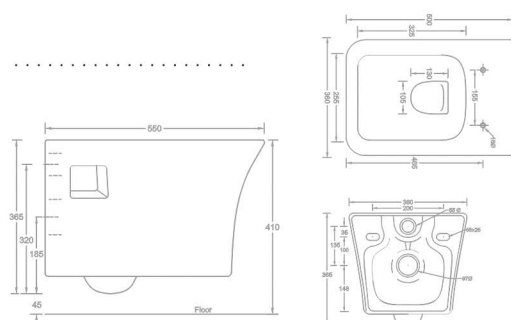



WALL HUNG

Closet

APOLLO (2004)

L-495, W-355, H-365mm

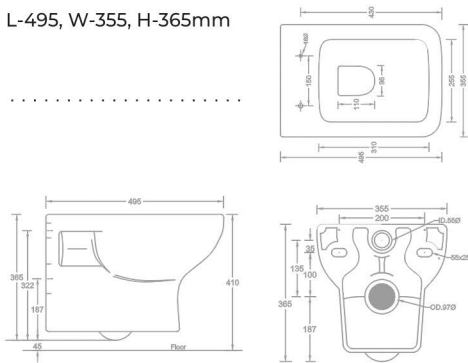

RUBIC (2005)

L-505, W-355, H-375mm

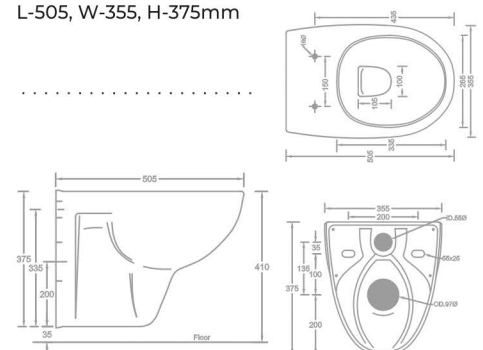

WALL HUNG

Closet

COSMO (2008)

L-540, W-365, H-410mm

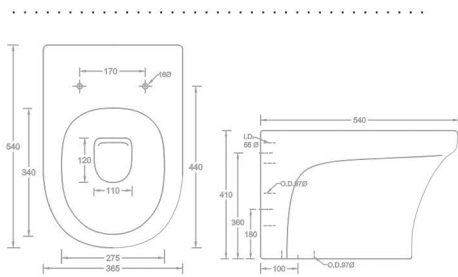

ASPIRE (2009)

L-560, W-365, H-400mm

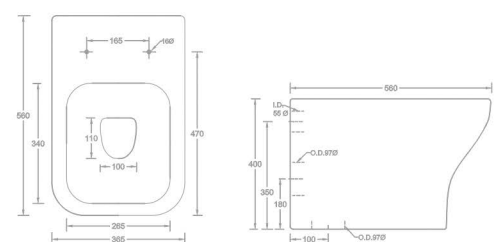



DELTA (2010)

L-710, W-375, H-745mm

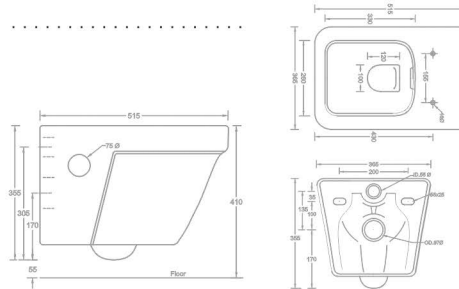

TABLE TOP

Basin



TOPIC (3001)

L-395, W-395, H-140mm



VITARA (3002)

L-360, W-715, H-140mm



SPIRIT (3003)
L-420, W-420, H-140mm



VIRGO (3004)
L-390, W-565, H-120mm



ROMA (3005)
L-420, W-420, H-170mm



TULI (3006)
L-415, W-415, H-130mm



CANDY (3007)
L-335, W-605, H-125mm



ORIS (3008)
L-415, W-415, H-130mm

TABLE TOP

Basin



SPENZO (3009)
L-380, W-495, H-130mm



NEXA (3010)
L-405, W-550, H-135mm

Lycos[®]
BATHWARE



TABLE TOP

Basin



OMEGA (3011)
L-350, W-585, H-155mm



KOSTA (3012)
L-350, W-420, H-175mm



SYNOVA (3013)
L-385, W-565, H-130mm



CANTO (3014)
L-380, W-585, H-145mm



EURO (3015)
L-370, W-465, H-140mm



WALL MOUNTED

Basin

KIVI (4001)

L-375, W-470, H-190mm

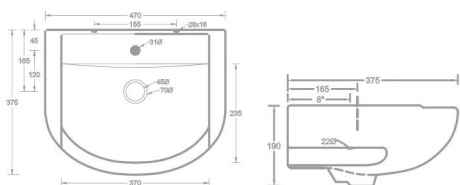

OPEL (4002)

L-315, W-470, H-200mm

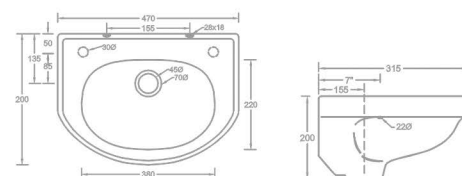



DOLI (4003)

L-345, W-465, H-140mm

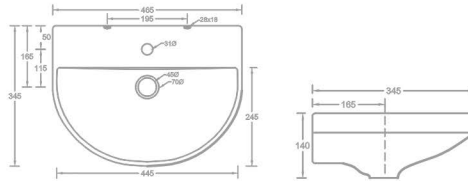

SOFIA (4004)

L-330, W-410, H-140mm

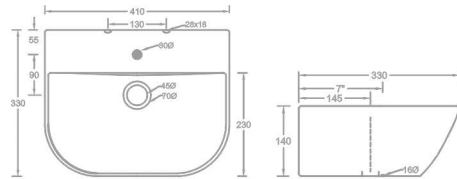

Pedestal wash

Basin

FLORA (5001WB)

L-425, W-565, H-860mm

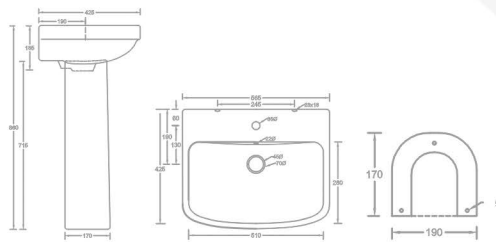

MOKA (5002WB)

L-385, W-455, H-835mm

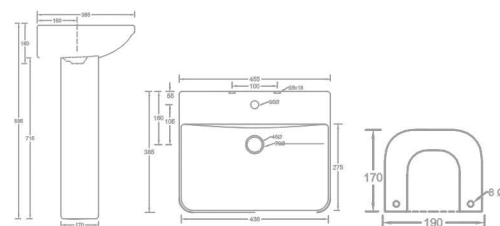

FANCY (5003WB)

L-440, W-580, H-865mm

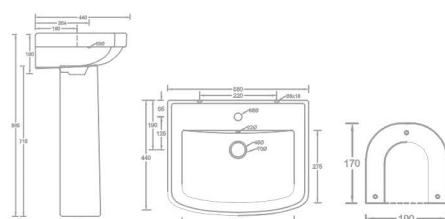



Pedestal wash

Basin

TOGO (5004WB)

L-450, W-575, H-875mm

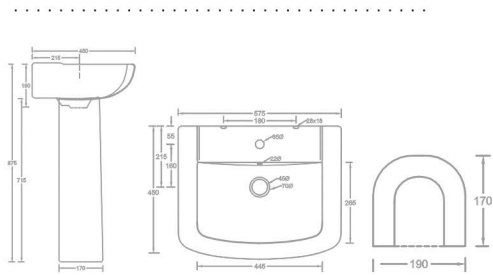

ZARA (5005WB)

L-450, W-535, H-865mm

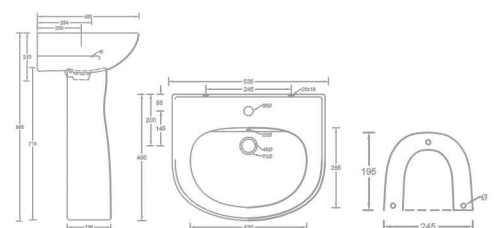



EVITA (5006WB)

L-510, W-575, H-875mm

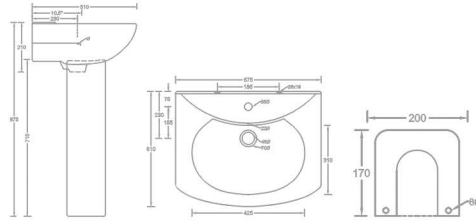

ONE PIECE

Basin

DOVE (8001)

L-440, W-480, H-325mm

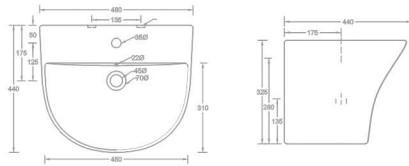

JUPITER (7003)

L-415, W-415, H-812mm

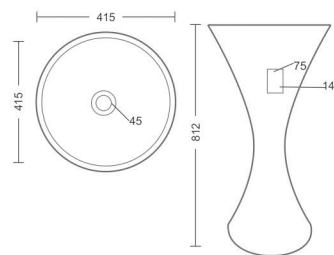

PLAZMA (8002)

L-370, W-460, H-310mm

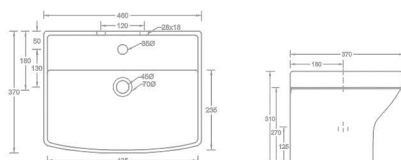



ANGLO - P

L-585, W-465, H-420mm

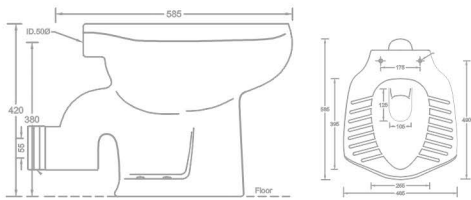

ANGLO - S

L-585, W-465, H-420mm

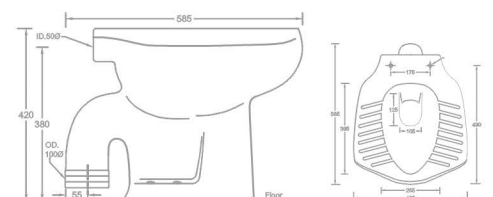



EWC - S

L-565, W-380, H-410mm

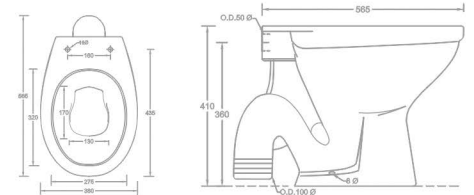

EWC SQUARE

L-520, W-345, H-410mm

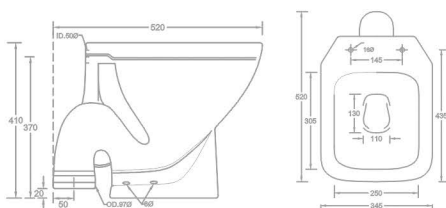

URINAL

EVA URINAL (6001)

L-350, W-390, H-625mm

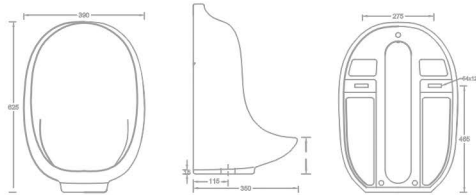

SPARK URINAL (6002)

L-000, W-325, H-590mm

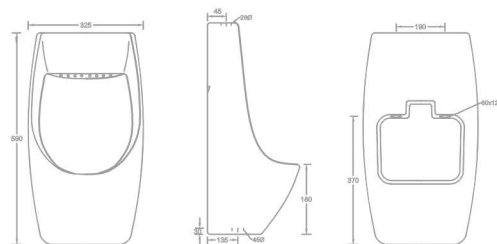

COMFORT URINAL (6003)

L-000, W-290, H-405mm

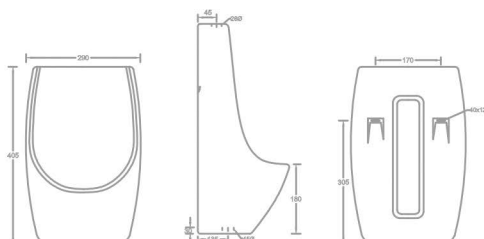



LADIES URINAL (6004)

L-365, W-455, H-100mm

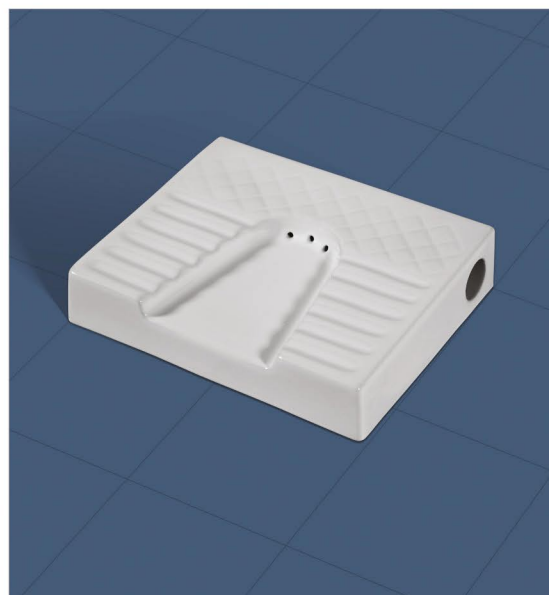
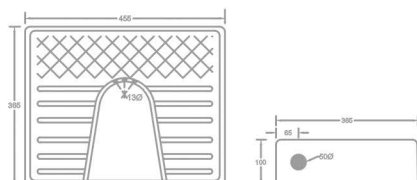

PAN

20' ORISSA PAN

L-535, W-450, H-265mm

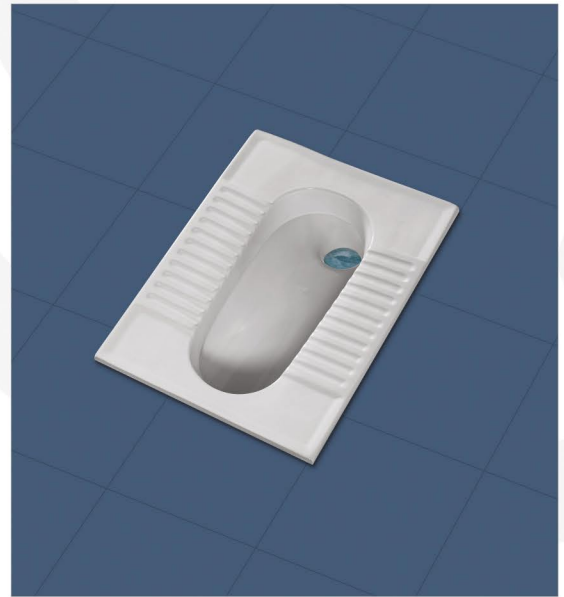
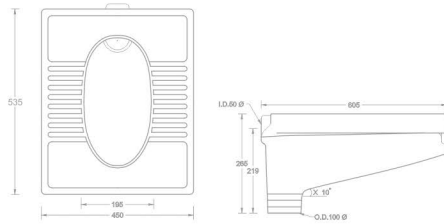

23' ORISSA PAN

L-605, W-450, H-265mm

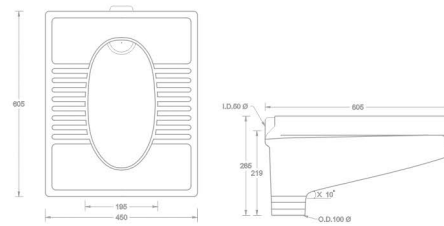

CT Pan

L-535, W-435, H-160mm

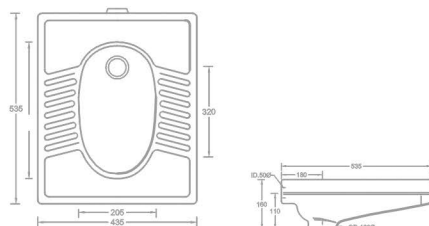

SEAT COVER



784



EWC EFFO



735



792



Ewc Classic



Ewc Slim



710



222



743



Anglo

CISTERN FLUSH TANK



Platinum Dual Flush



Classic Cistern Side Handle



Classic Cistern Top Flush

Accessories



P Trap



Waste Coupling



Health Faucet



Urinal Bracket



Urinal Sensor



One Piece Fitting



Wash Basin



Jet Spray

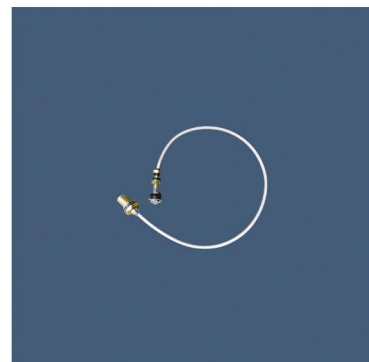

Inbjilt Jet Spray



Wall Hung



Gasket & Chair Bracket

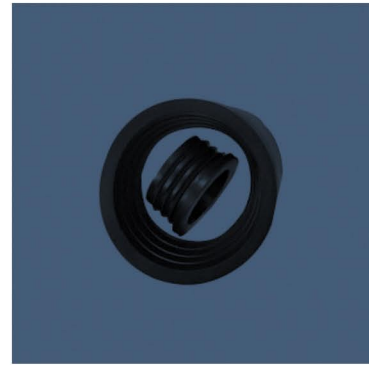

Inlet & Outlet Coupler

Installation Instruction

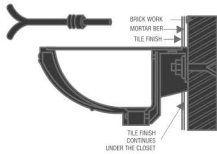

WALL HUNG BASIN

As per shown in the picture, the rag bolt must be grouted into the cement/concrete wall. The bolts must be fixed to the cement/concrete wall. Allow setting & checking than install it using nut and washer.

COUNTER WASHBASIN

At the beginning

1. A skilled or experienced person should install counter lavatories.
2. Avoid using adhesive with this product.
3. Check the waste area and supply tubing if required.
4. Do not open the lavatory from its protective carton until you are ready for installation.
5. Please follow all local building and plumbing codes.



MATERIAL & TOOLS

Measure tape, Keyhole or saber saw, Hammer, Glasses, Rags or Paper toweling, Drill (1/2 dia, drill bit or larger), Pencil, sealant, sharp knife or scissors.

INSTALLATION OF LAVATORY

Please Note : Please install it in a way that future removal from underneath the counter top is possible without damaging the counter top.

1. Please check the desired location for clearance between the back splash, faucet, Fixture and cabinet.
2. Please cut the template.
3. Please carefully trace the template on the counter top directed.
4. Please mark the faucet hole centerline on the counter top.
5. Please drill a 1/2" pilot on the inside of the cut line.

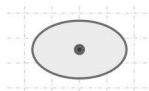

For Wood Counter tops:

1. Mark and pre-drill the wood screw holes at the locations shown on the template.
2. Waterproof any exposed areas of wood.

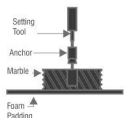

For Marble Counter tops:

1. Position the counter top upside down on foam padding to protect the surface. Mark and drill 3/6" holes 5/8" deep at the locations shown on the template.
2. Use a setting tool and hammer to secure the anchors.



For All Installations:

1. If the counter top has not been installed, install it at this time.
2. Drill the faucet holes according to the faucet installation instructions.
3. Install the faucet to the counter top according to the manufacture's instructions.
4. Install the drain to the lavatory according to the manufacture's instructions.

LYCOS BATHWARE LLP.

MFG. Sanitaryware

Survey No. 850/1, Lakhdirpur Road,
Near New Antiek Vitrified,
Morbi 363 642 (Guj.) India.

Call. +91 99783 77772, +91 97121 88488

Mail. lycosbathware@gmail.com
Web. www.lycosbathware.com